

# 980.2st

Two Speed Self-Tailing Winch

Winch Parts  
Installation  
Service

# HARKEN®

## Parts List

008	Pawl
038	Pawl Spring
1709	Plastic Washer
1738	Spring
5530	Pawl Gear
5533	Pawl Gear
5544	Spacer
5547	Gear Shaft
5548	Gear Shaft
5834	Spindle Guide
6009	Screw
6143	Top Screw
6337	Balls
6391	Screw
6432	Screw
26029	Plastic Washer
26044	Plastic Bushing
26048	Split Ring
26648	Handle Socket
26682	Gear
27451	Gear
27454	Washer
27588	Thrust Bearing
27668	Stripper Arm Support
27879	Thrust Washer
28053	Plastic Washer
28683	Ratchet Gear
28685	Bushing
28687	Ratchet Gear
30127	Bushing
30128	Plastic Bushing
30807	Spacer
32545	Top Cap
32716	Center Spindle
37857	Spring Support
37860	Upper Jaw
37861	Lower Jaw
37862	Stripper Arm
37863	Cover
38628	Center Stem
38655	Red Ring
701888	Bearing
726060	Bearing
726073	Bearing
726664	Bearing
938632	Aluminum Drum
938637	Chrome Drum
938684	Winch Base

When ordering parts, please include a "B" before each number (i.e. B008)

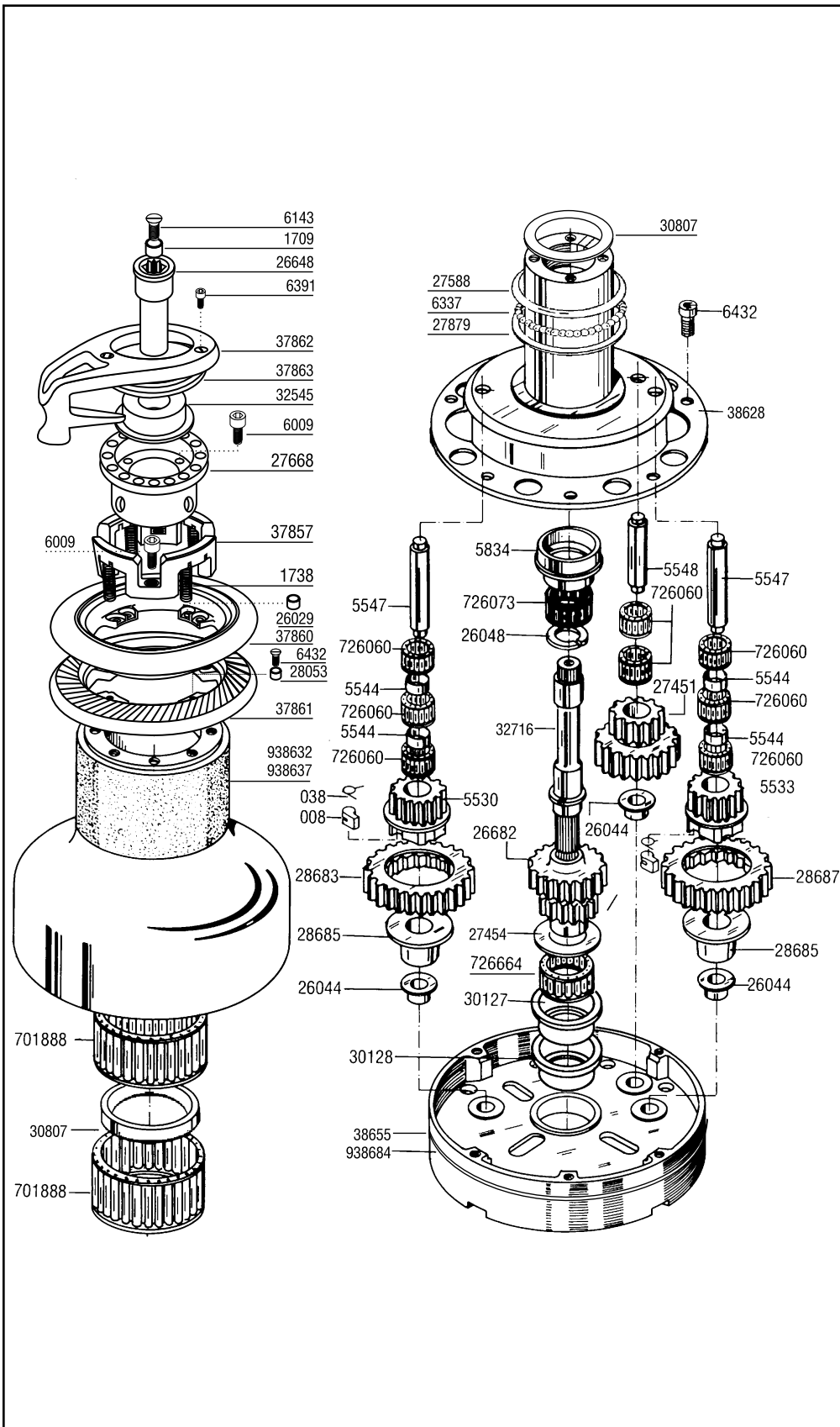

## Service winch before the sailing season begins and once during.

### Required Tools

Screwdriver	Rags
Allen Wrench (6 mm)	Solvent
Allen Wrench (5 mm)	Oil
Plastic Head Hammer or Mallet	Grease
Small Knife	<b>Suggested Service Kits</b>
Brush	BK4512 10 008 Pawls
	10 038 Springs
	BK4513 100 ml Grease

### Installing Winch

- Make sure mounting surface is flat.
- Check sheet entry angle. Should be at least 8° (see drawing).
- Open winch.
- Position winch on deck with drive gear where sheet enters winch drum. Mark holes.
- Remove winch and drill holes.
- Mount using six (6) 3/8" (10 mm) flathead machine screws.
- Apply bedding compound. Bolt winch to boat.
- Clean excess bedding compound from base drain holes.
- Lubricate and close winch.

### Minimum/Maximum Line Diameter

Harken winches feature spring-loaded self-tailing jaws which adjust automatically to the following line sizes:

Minimum	3/8" (10 mm)
Maximum	13/16" (21 mm)

### Positioning Stripper Arm

- Loosen top screw (6143).
- Remove handle socket (26648).
- Lift stripper arm (37862) and position as desired.

### Opening Winch

- Remove top screw (6143).
- Remove handle socket (26648).
- Remove 3 screws (6391) in stripper arm (37862).
- Remove stripper arm (37862).
- Remove 4 screws (6009) in stripper arm base (27668).
- Lift support base.
- Lift off drum.

### Servicing Winch

- Remove bearings from center stem.
- Drum support bearing 27588/6337/27879 cannot be removed; clean with solvent and lubricate lightly with grease.
- Remove allen screws (6432) holding center stem to base.
- Remove center stem (38628) carefully.
- Remove pawls and springs - service as below.
- Remove all bearings, gear shafts and gears.
- Service one gear shaft assembly at a time to avoid confusion.**
- Inspect plastic bushings for wear.
- Remove all pawls and springs and service (see below).
- Use brush to lubricate all gears, gear shafts, bearings, teeth and all moving parts lightly with grease.
- Replace pawls and springs and lubricate lightly with oil.
- Assemble and close winch.

### Servicing Pawls

- Catch spring with knife and hold against pawl.
- Lift out pawl.
- Clean and check for wear.
- Place spring against pawl with straight leg against pawl.
- Hold spring closed and slip pawl into pawl socket.
- Lubricate pawls using oil.

### Mounting

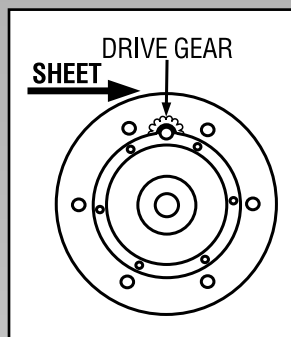

Position drive gear where sheet enters winch drum.

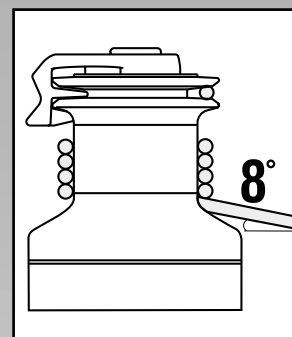

Sheet entry angle must be at least 8°.

### Servicing Winch

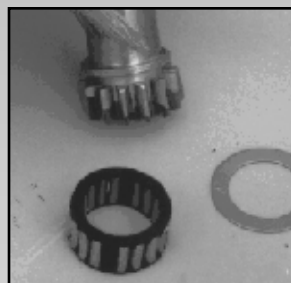

Clean all parts with solvent except 37857/37863.

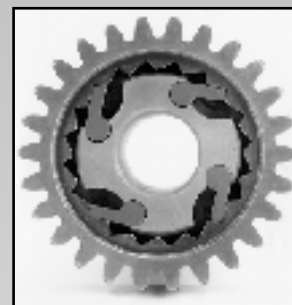

Use a brush to spread a light, even coat of grease.



Correct



Incorrect

If ratchet gear is mounted backwards, winch will slip.

### Servicing Pawls

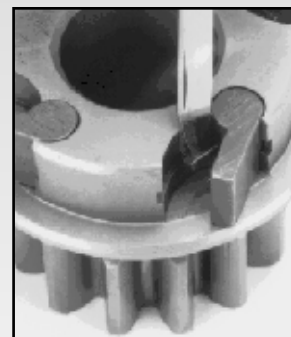

Use knife to free captive spring.

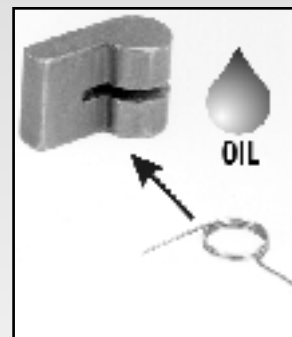

Insert spring with straight leg against pawl. Use oil for lubrication.

4575/5-99



# HARKEN®