

64.2st

Two Speed Self-Tailing Winch

Winch Parts Installation Service

HARKEN®

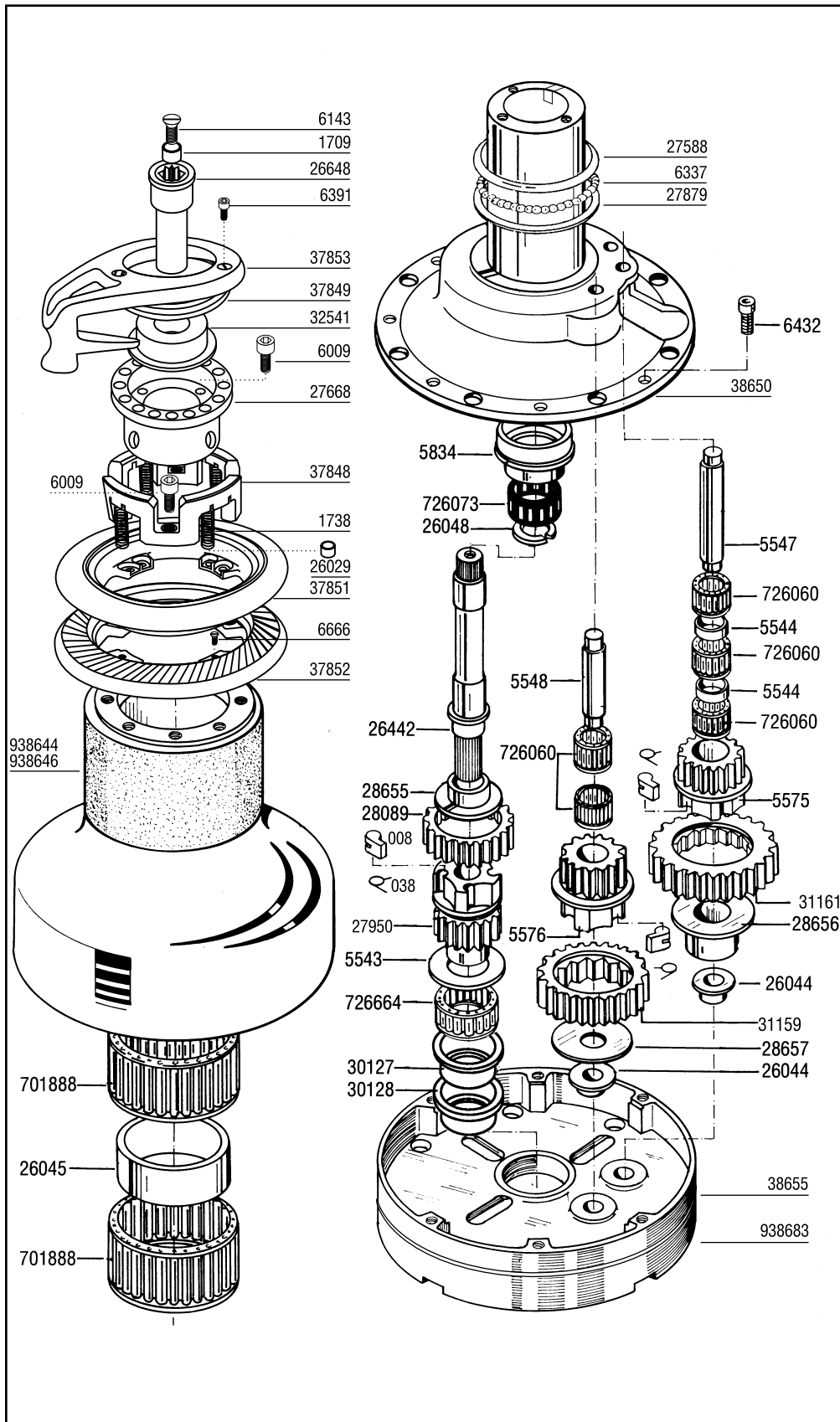

Parts List

008	Pawl
038	Pawl Spring
1709	Plastic Washer
1738	Spring
5543	Washer
5544	Spacer
5547	Gear Shaft
5548	Gear Shaft
5575	Pawl Gear
5576	Pawl Gear
5834	Bushing
6009	Screw
6143	Top Screw
6337	Stainless Steel Ball
6391	Screw
6432	Screw
6666	Screw
26029	Plastic Washer
26044	Bushing
26045	Spacer
26048	Split Washer
26442	Spindle
26648	Handle Socket
27588	Thrust Bearing
27668	Stripper Arm Base
27879	Thrust Washer
27950	Pawl Gear
28089	Ratchet Gear
28655	Washer
28656	Bushing
28657	Washer
30127	Bushing
30128	Bushing
31159	Ratchet Gear
31161	Ratchet Gear
32541	Top Cap
37848	Springs Support
37849	Cover
37851	Upper Jaw
37852	Lower Jaw
37853	Stripper Arm
38650	Center Stem
38655	Red Ring
701888	Bearing
726060	Bearing
726073	Bearing
726664	Bearing
938644	Aluminum Drum
938646	Chrome Drum
938683	Base

When ordering parts, please include a "B" before each number (i.e. B008)

Service winch before the sailing season begins and once during.

Required Tools

Screwdriver
Allen Wrench (6 mm)
Allen Wrench (5 mm)
Plastic Head Hammer or Mallet
Small Knife
Brush

Rags
Solvent
Oil
Grease
Suggested Service Kits
BK4512 10 008 Pawls
10 038 Springs
BK4513 100 ml Grease

Installing Winch

- Make sure mounting surface is flat.
- Check sheet entry angle. Should be at least 8° (see drawing).
- Open winch.
- Position winch on deck with drive gear where sheet enters winch drum. Mark holes.
- Remove winch and drill holes.
- Mount using six (5) 3/8" (5 mm) flathead machine screws.
- Apply bedding compound. Bolt winch to boat.
- Clean excess bedding compound from base drain holes.
- Lubricate and close winch.

Minimum/Maximum Line Diameter

- Harken winches feature spring-loaded self-tailing jaws which adjust automatically to the following line sizes:
- Minimum 3/8" (8 mm)
- Maximum 3/4" (18 mm)

Positioning Stripper Arm

- Loosen top screw (6143).
- Remove handle socket (26648).
- Lift stripper arm (37853) and position as desired.

Opening Winch

- Remove top screw (6143).
- Remove handle socket (26648).
- Remove 3 screws (6391) in stripper arm (37853).
- Remove stripper arm (37853).
- Remove 4 screws (6009) in stripper arm base (27668).
- Lift support base.
- Lift off drum.

Servicing Winch

- Remove bearings from center stem.
- Drum support bearing 27588/6337/27879 cannot be removed; clean with solvent and lubricate lightly with grease.
- Remove allen screws (6432) holding center stem to base.
- Remove center stem (38650) carefully.
- Remove pawls and springs - service as below.
- Remove all bearings, gear shafts and gears.
- Service one gear shaft assembly at a time to avoid confusion.**
- Inspect plastic bushings for wear.
- Remove all pawls and springs and service (see below).
- Use brush to lubricate all gears, gear shafts, bearings, teeth and all moving parts lightly with grease.
- Replace pawls and springs and lubricate lightly with oil.
- Assemble and close winch.

Servicing Pawls

- Catch spring with knife and hold against pawl.
- Lift out pawl.
- Clean and check for wear.
- Place spring against pawl with straight leg against pawl.
- Hold spring closed and slip pawl into pawl socket.
- Lubricate pawls using oil.

Mounting

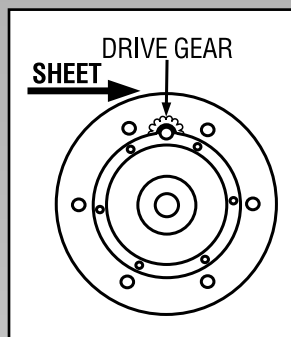

Position drive gear where sheet enters winch drum.

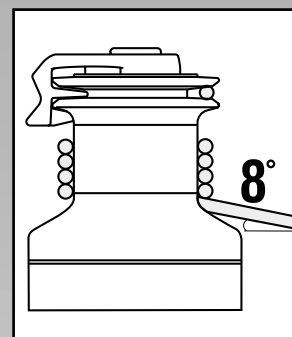

Sheet entry angle must be at least 8°.

Servicing Winch

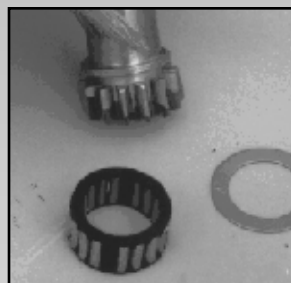

Clean all parts with solvent except 37848/37849.



Use a brush to spread a light, even coat of grease.

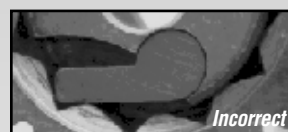
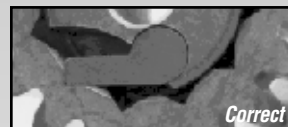
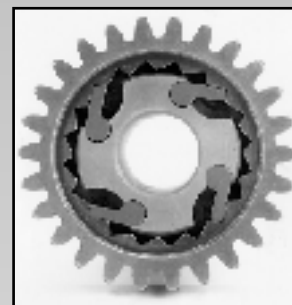

If ratchet gear is mounted backwards, winch will slip.

Servicing Pawls

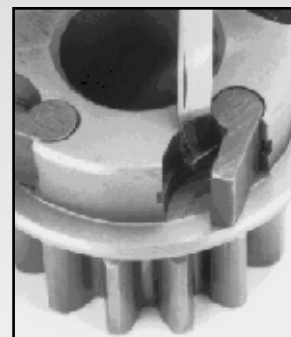

Use knife to free captive spring.

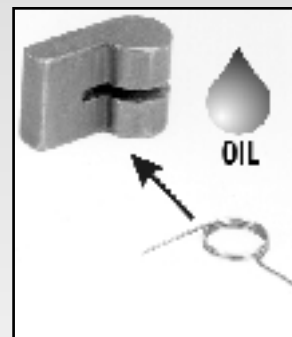

Insert spring with straight leg against pawl. Use oil for lubrication.

4569/5-99



HARKEN