

# 44.2st

## Two Speed Self-Tailing Winch

# HARKEN®

### Winch Parts Installation Service

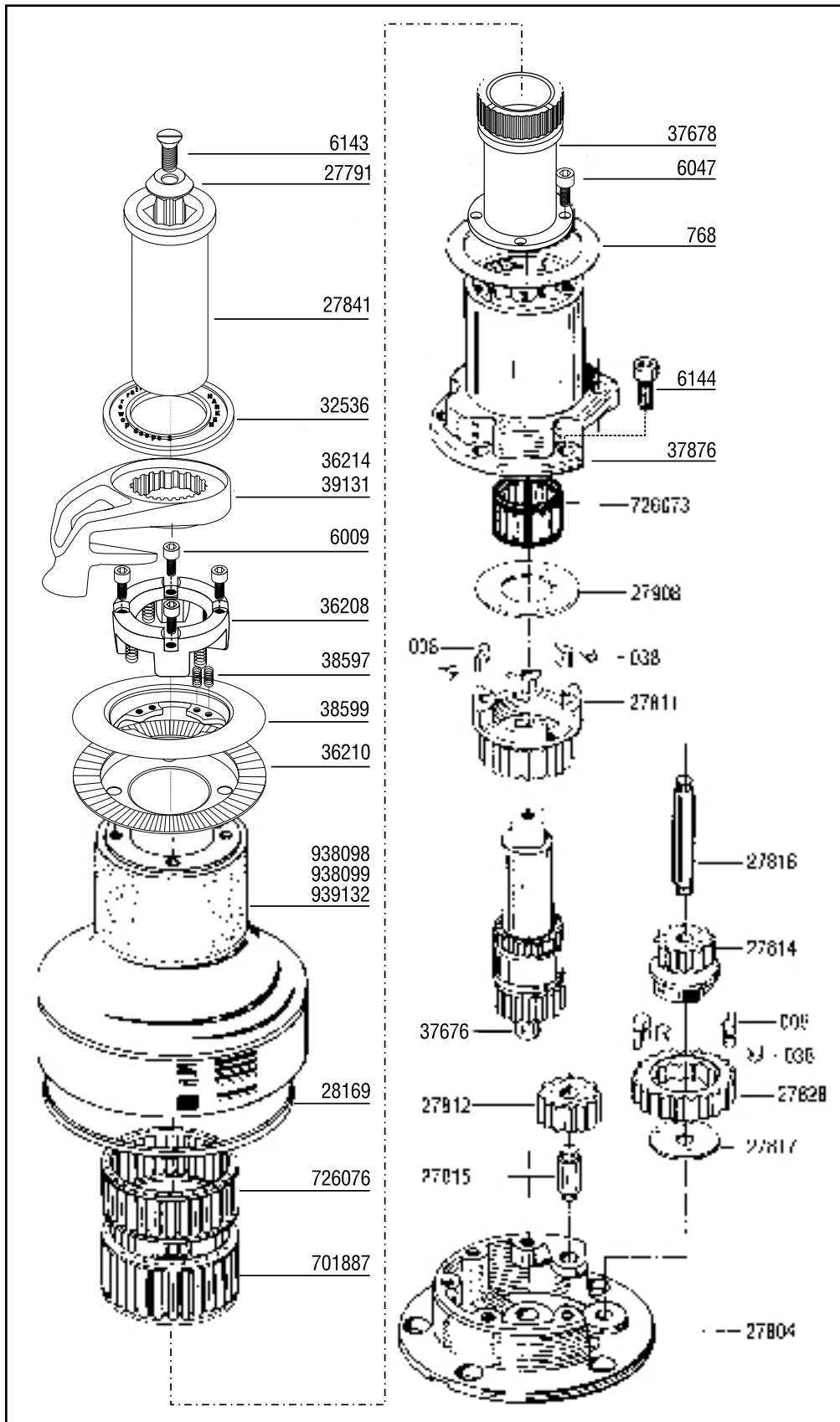

#### Required Tools

Screwdriver
Plastic Head Hammer or Mallet
Small Knife
Brush
Rags
Solvent
Oil
Grease

#### Parts List

008	Pawl
038	Pawl Spring
768	Thrust Washer
6009	Screw
6047	Screw
6143	Top Screw
6144	Screw
27791	Plastic Washer
27804	Base
27811	Pawl Gear
27812	Gear
27814	Pawl Gear
27815	Gear Shaft
27816	Gear Shaft
27817	Cover Plate
27828	Ratchet Gear
27841	Handle Socket
27908	Washer
28169	Red Line Ring
32536	Top Cap
36208	Springs Support
36210	Lower Jaw
36214	Chrome Stripper Arm
37676	Spindle
37678	Stripper Arm Support
37876	Center Stem
38597	Spring
38599	Upper Jaw
39131	Bronze Stripper Arm
701887	Bearing
726073	Bearing
726076	Bearing
938098	Aluminum Drum
938099	Chrome Drum
939132	Bronze Drum

#### Suggested Service Kits

BK4512	10	008 Pawls
	10	038 Springs
BK4513	100 ml	Grease

*When ordering parts, please include a "B" before each number (i.e. B008).*

## Service winch before the sailing season begins and once during.

### ■ Installing Winch

Make sure mounting surface is flat.  
Check sheet entry angle. Should be at least 8° (see drawing).  
Open winch.  
Position winch on deck with drive gear where sheet enters winch drum. Mark holes.  
Remove winch and drill holes.  
Mount using five (5) 5/16" (8 mm) flathead machine screws.  
Apply bedding compound. Bolt winch to boat.  
Clean excess bedding compound from base drain holes.  
Lubricate and close winch.

### ■ Minimum/Maximum Line Diameter

Harken winches feature spring-loaded self-tailing jaws which adjust automatically to the following line sizes:

Minimum 5/16" (8 mm)

Maximum 9/16" (14 mm)

### ■ Positioning Stripper Arm

Loosen top screw.  
Remove handle socket.  
Lift stripper arm and position as desired.

### ■ Opening Winch

Remove top screw.  
Lift off drum and stripper arm.

### ■ Servicing Winch

Remove pawls and springs - service as below.  
Remove bearing, gear shaft and gears.  
To reach interior shaft bearing, winch must be removed from deck.  
Clean all parts except 36208, 38599 and 36210 with rag and solvent.  
**Important: Use freshwater only on parts 36208, 38599 and 36210.**  
Use brush to lubricate all moving parts lightly with grease.  
Replace pawls and springs and lubricate lightly with oil.  
Assemble and close winch.

### ■ Servicing Pawls

Catch spring with knife and hold against pawl.  
Lift out pawl.  
Clean and check for wear.  
Place spring against pawl with straight leg against pawl.  
Hold spring closed and slip pawl into pawl socket.  
Lubricate pawls using oil.

#### Mounting

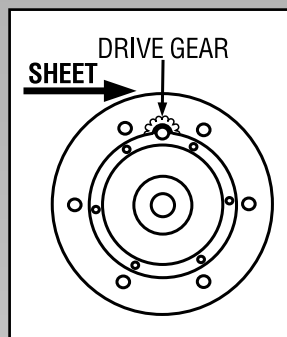

Position drive gear where sheet enters winch drum.

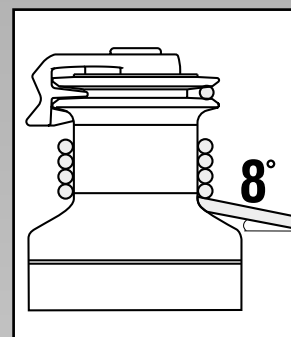

Sheet entry angle must be at least 8°.

#### Servicing Winch

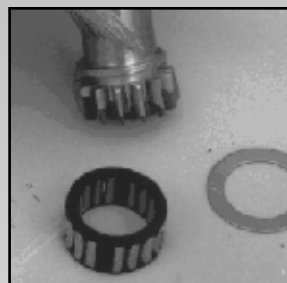

Clean all parts, except 36208, 38599, and 36210, with solvent.

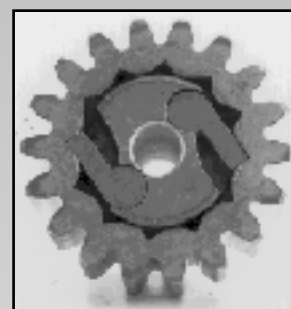

Correct



Use a brush to spread a light, even coat of grease.

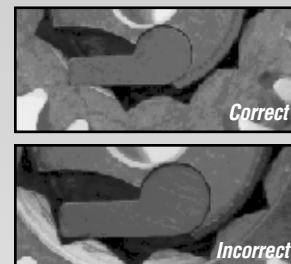

Incorrect

If ratchet gear is mounted backwards, winch will slip.

#### Servicing Pawls

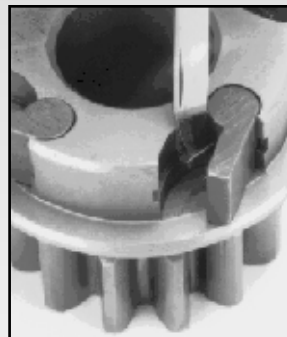

Use knife to free captive spring.

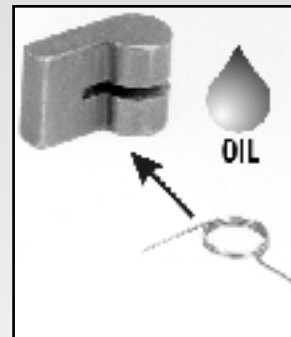

Insert spring with straight leg against pawl. Use oil for lubrication.

4563/2-99



# HARKEN