

32.2st

Two Speed Self-Tailing Winch

Winch Parts Installation Service

HARKEN®

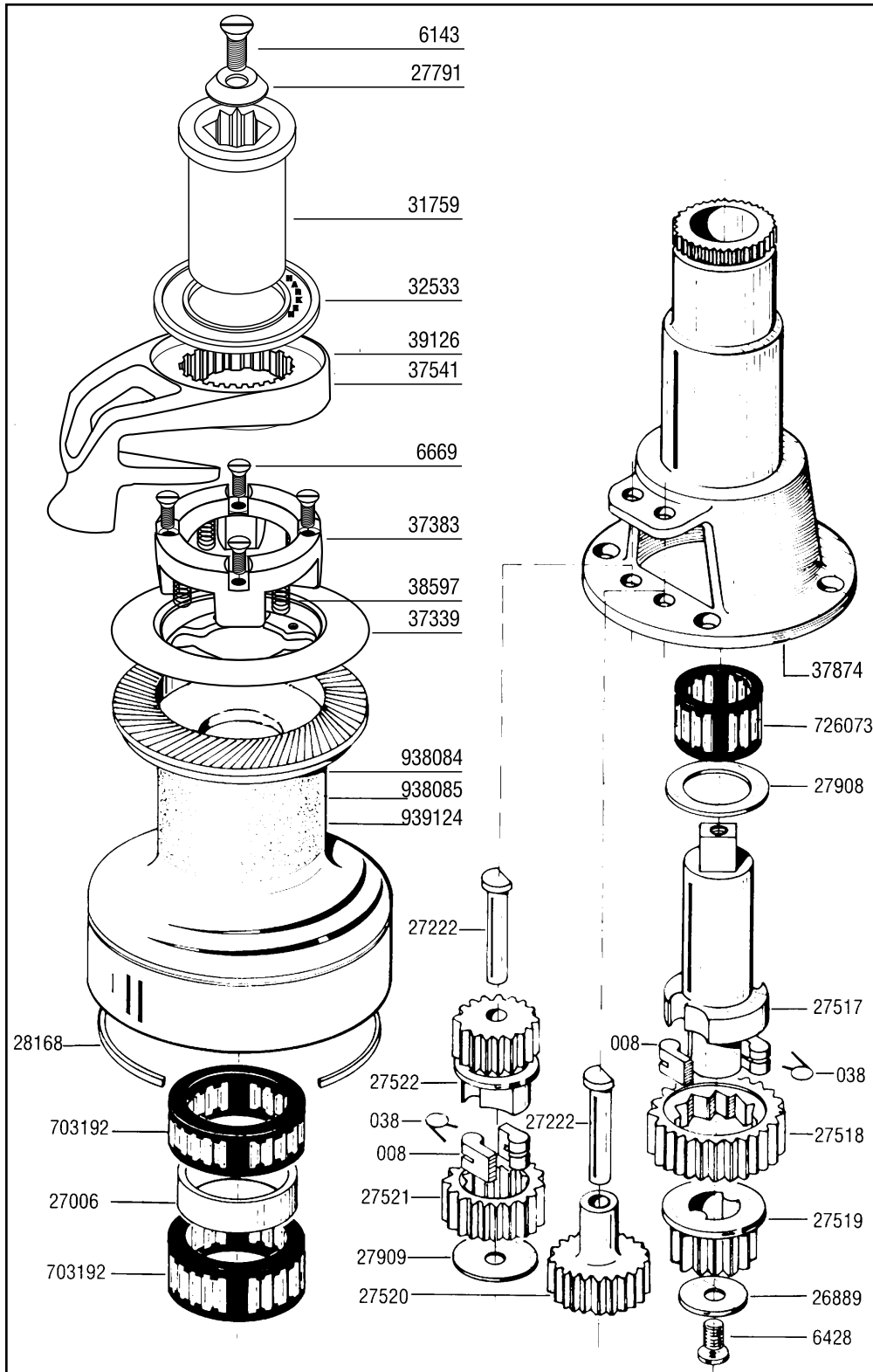

Required Tools

| |
|-------------------------------|
| Screwdriver |
| Plastic Head Hammer or Mallet |
| Small Knife |
| Brush |
| Rags |
| Solvent |
| Oil |
| Grease |

Parts List

| | |
|--------|---------------------|
| 008 | Pawl |
| 038 | Pawl Spring |
| 6143 | Top Screw |
| 6428 | Screw |
| 6669 | Screw |
| 26889 | Cover Plate |
| 27006 | Bearing Spacer |
| 27222 | Gear Shaft |
| 27517 | Spindle |
| 27518 | Ratchet Gear |
| 27519 | Gear |
| 27520 | Gear |
| 27521 | Gear |
| 27522 | Pawl Gear |
| 27791 | Plastic Washer |
| 27908 | Washer |
| 27909 | Cover Plate |
| 28168 | Red Line Ring |
| 31759 | Handle Socket |
| 32533 | Top Cap |
| 37339 | Upper Jaw |
| 37383 | Springs Support |
| 37541 | Chrome Stripper Arm |
| 37874 | Center Stem |
| 38597 | Spring |
| 39126 | Bronze Stripper Arm |
| 703192 | Bearing |
| 726073 | Bearing |
| 938084 | Aluminum Drum |
| 938085 | Chrome Drum |
| 939124 | Bronze Drum |

Suggested Service Kits

| | | |
|--------|--------|-------------|
| BK4512 | 10 | 008 Pawls |
| | 10 | 038 Springs |
| BK4513 | 100 ml | Grease |

When ordering parts, please include a "B" before each number (i.e. B008).

Service winch before the sailing season begins and once during.

■ Installing Winch

- Make sure mounting surface is flat.
- Check sheet entry angle. Should be at least 8° (see drawing).
- Open winch.
- Position winch on deck with drive gear where sheet enters winch drum. Mark holes.
- Remove winch and drill holes.
- Mount using five (5) 1/4" (6 mm) flathead machine screws.
- Apply bedding compound. Bolt winch to boat.
- Clean excess bedding compound from base drain holes.
- Lubricate and close winch.

■ Minimum/Maximum Line Diameter

Harken winches feature spring-loaded self-tailing jaws which adjust automatically to the following line sizes:

- Minimum 5/16" (8 mm)
- Maximum 1/2" (12 mm)

■ Positioning Stripper Arm

- Loosen top screw.
- Remove handle socket.
- Lift stripper arm and position as desired.

■ Opening Winch

- Remove top screw.
- Lift off drum and stripper arm.

■ Servicing Winch

- Remove pawls and springs - service as below.
- Remove bearing, gear shaft and gears.
- To reach interior shaft bearing, winch must be removed from deck.
- Clean all parts except 37383 and 37339 with rag and solvent.
- Important: Use freshwater only on parts 37383 and 37339**
- Use brush to lubricate all moving parts lightly with grease.
- Replace pawls and springs and lubricate lightly with oil.
- Assemble and close winch.

■ Servicing Pawls

- Catch spring with knife and hold against pawl.
- Lift out pawl.
- Clean and check for wear.
- Place spring against pawl with straight leg against pawl.
- Hold spring closed and slip pawl into pawl socket.
- Lubricate pawls using oil.

Mounting

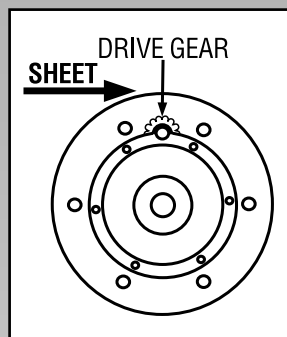

Position drive gear where sheet enters winch drum.

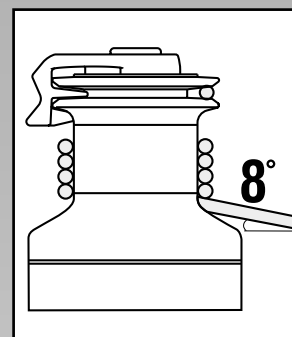

Sheet entry angle must be at least 8°.

Servicing Winch

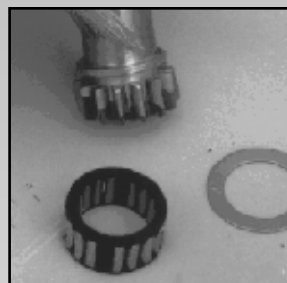

Clean all parts, except 37383 and 37339, with solvent.

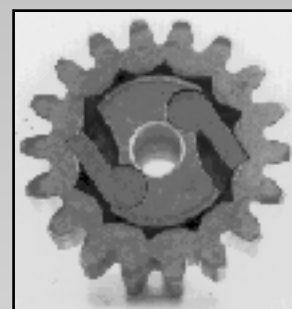

Use a brush to spread a light, even coat of grease.

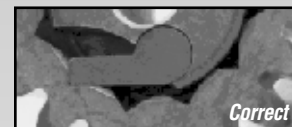

If ratchet gear is mounted backwards, winch will slip.

Servicing Pawls

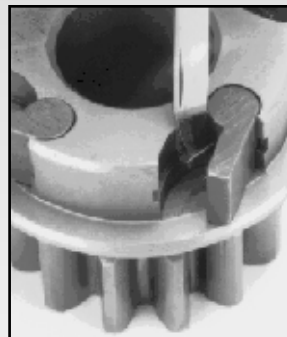

Use knife to free captive spring.

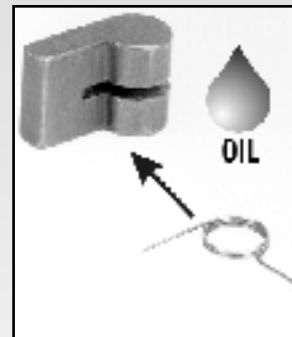

Insert spring with straight leg against pawl. Use oil for lubrication.

4561/2-99



HARKEN