

16st

One Speed Self-Tailing Winch

Winch Parts Installation Service

HARKEN®

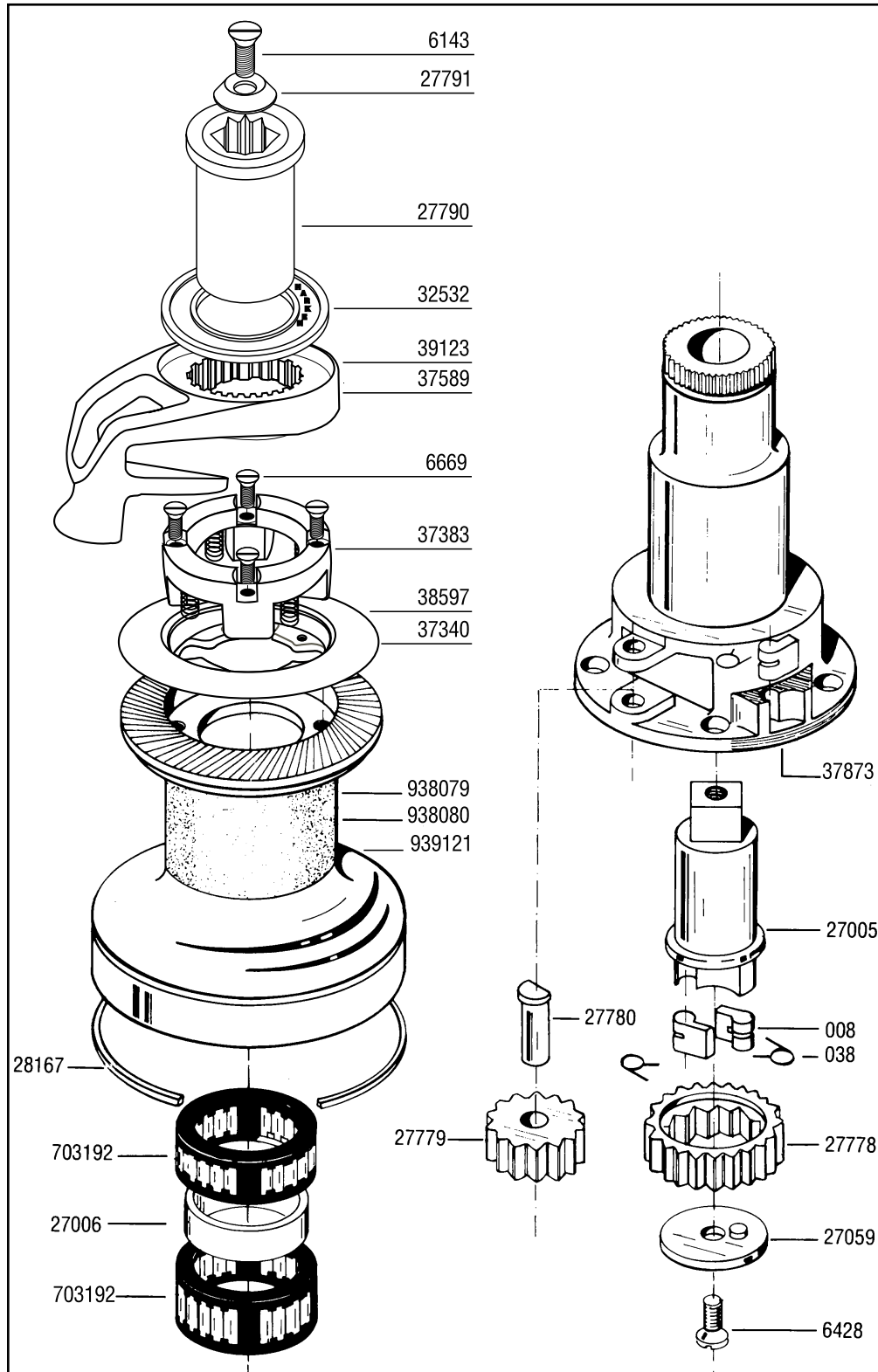

Required Tools

Screwdriver
Plastic Head Hammer or Mallet
Small Knife
Brush
Rags
Solvent
Oil
Grease

Parts List

008	Pawl
038	Pawl Spring
6669	Screw
6143	Top Screw
6428	Screw
27005	Spindle
27006	Bearing Spacer
27059	Cover Plate
27778	Ratchet Gear
27779	Gear
27780	Gear Shaft
27790	Handle Socket
27791	Plastic Washer
28167	Red Line Ring
32532	Top Cap
37340	Upper Jaw
37383	Spring Support
37589	Chrome Stripper Arm
37873	Center Stem
38597	Spring
39123	Bronze Stripper Arm
703192	Bearing
938079	Aluminum Drum
938080	Chrome Drum
939121	Bronze Drum

Suggested Service Kits

BK4512	10	008 Pawls
	10	038 Springs
BK4513		100ml Grease

When ordering parts, please include a "B" before each number (i.e. B008).

Service winch before the sailing season begins and once during.

■ Installing Winch

Make sure mounting surface is flat.
Check sheet entry angle. Should be at least 8° (see drawing).
Open winch.
Position winch on deck with drive gear where sheet enters winch drum. Mark holes.
Remove winch and drill holes.
Mount using five (5) 1/4" (6 mm) flathead machine screws.
Apply bedding compound. Bolt winch to boat.
Clean excess bedding compound from base drain holes.
Lubricate and close winch.

■ Minimum/Maximum Line Diameter

Harken winches feature spring-loaded self-tailing jaws which adjust automatically to the following line sizes:

Minimum 1/4" (6 mm)
Maximum 1/2" (12 mm)

■ Positioning Stripper Arm

Loosen top screw.
Remove handle socket.
Lift stripper arm and position as desired.

■ Opening Winch

Remove top screw.
Lift off drum and stripper arm.

■ Servicing Winch

Remove pawls and springs - service as below.
Remove bearings, gear shaft and gears.
To remove center spindle, winch must be removed from deck.
Clean all parts except 37383 and 37340 with rag and solvent.
Important: Use freshwater only on parts 37383 and 37340
Use brush to lubricate all moving parts lightly with grease.
Replace pawls and springs and lubricate lightly with oil.
Assemble and close winch.

■ Servicing Pawls

Catch spring with knife and hold against pawl.
Lift out pawl.
Clean and check for wear.
Place spring against pawl with straight leg against pawl.
Hold spring closed and slip pawl into pawl socket.
Lubricate pawls using oil.

Mounting

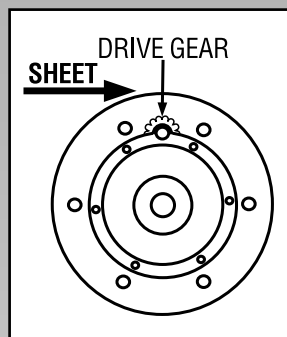

Position drive gear where sheet enters winch drum.

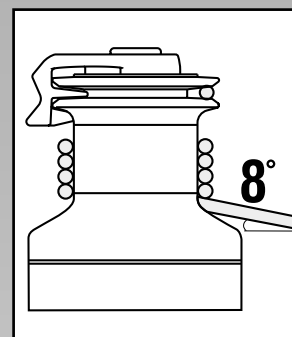

Sheet entry angle must be at least 8°.

Servicing Winch

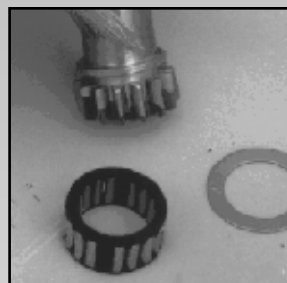

Clean all parts, except 37383 and 37340, with solvent.

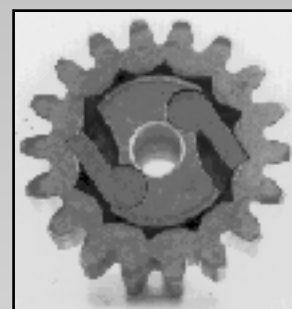

Use a brush to spread a light, even coat of grease.

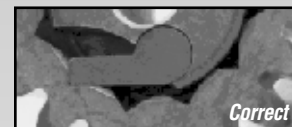

If ratchet gear is mounted backwards, winch will slip.

Servicing Pawls

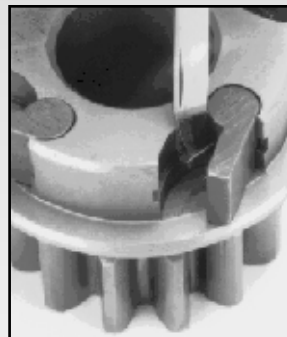

Use knife to free captive spring.

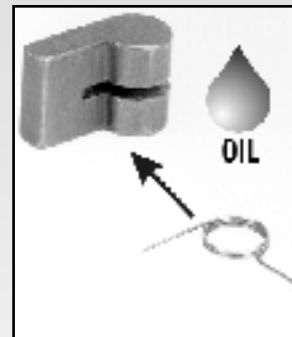

Insert spring with straight leg against pawl. Use oil for lubrication.

HARKEN

1251 E. Wisconsin Ave., Pewaukee, WI 53072 USA • Tel: (414) 691-3320 • Fax: (414) 691-3008 • Web: <http://www.harken.com> • E-main: harken@harken.com
Via Della Cerca, 12/14, 22070 Lurago Marinone, Como, Italy • Fax: (39) 031.3520031 • Tel: (39) 031.938840 • E-mail: harken.italy@comm2000.it

4560/2-99

